

## 094 system mario nanni 2003

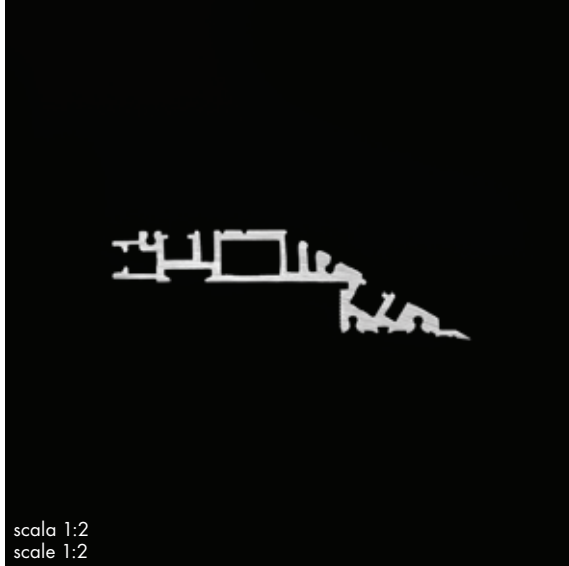

scala 1:2  
scale 1:2

premio innovation batimat 2005 parigi  
innovation award batimat 2005 paris

**094 è un sistema integrato nell'architettura. ne definisce spazi, volumi e superfici. può essere cablato con diverse sorgenti luminose: led, lampade alogene, alogenuri, lampade fluorescenti per creare una linea di luce continua e sistemi per la luce di emergenza. ideato per diverse soluzioni architettoniche, suggerisce non solo nuovi modi di disegnare lo spazio con la luce, ma permette anche di integrare i sistemi impiantistici e tecnologici alle esigenze formali. è disponibile una versione che supporta un cartongesso di spessore massimo 15mm e una versione che supporta un cartongesso di spessore massimo 18mm studiato appositamente per il mercato americano.**

**094 system is a system which integrates with architecture. it defines spaces, volumes and surfaces. it can be fitted with different light sources: led, halogen and metal halide lamps, fluorescent lamps to create a continuous light line and systems for emergency lights. conceived for different architectural solutions it suggests not only new ways to design space with light but also gives the possibility to integrate plant engineering and technological systems with formal necessities. available in a version that supports plasterboard with a maximum thickness of 15mm and a version that supports plasterboard with a maximum thickness of 18mm designed especially for the american market.**



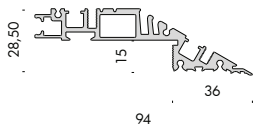

**profilo 094 system h.15** i

<b>F6.094.02</b>	profilo alluminio naturale natural aluminium profile	2 pz 2 pcs	500mm	1,3
<b>F6.094.02.N</b>	profilo alluminio nero black aluminium profile	2 pz 2 pcs	500mm	1,3
<b>F6.094.04</b>	profilo alluminio naturale natural aluminium profile	2 pz 2 pcs	1000mm	2,5
<b>F6.094.04.N</b>	profilo alluminio nero black aluminium profile	2 pz 2 pcs	1000mm	2,5
<b>F6.094.06</b>	profilo alluminio naturale natural aluminium profile	2 pz 2 pcs	2000mm	5,0
<b>F6.094.06.N</b>	profilo alluminio nero black aluminium profile	2 pz 2 pcs	2000mm	5,0
<b>F6.094.08</b>	profilo alluminio naturale natural aluminium profile	2 pz 2 pcs	3000mm	7,6
<b>F6.094.08.N</b>	profilo alluminio nero black aluminium profile	2 pz 2 pcs	3000mm	7,6
	completi di giunti di congiunzione complete with connection joints			
<b>importante nota per il montaggio:</b> per una buona esecuzione dei lavori nel cartongesso da 12mm utilizzare sempre lo spessore compensatore cod.F6.094.50				
<b>important installation note:</b> for good results when using 12mm plasterboard, item F6.094.50 thickness balancer should always be used.				
* <b>F6.094.09</b>	pallet profilo alluminio naturale pallet natural aluminium profile	100 pz 100 pcs	3000mm	412
* <b>F6.094.09.N</b>	pallet profilo alluminio nero pallet black aluminium profile	100 pz 100 pcs	3000mm	412
* giunti esclusi joints excluded				
<b>F6.094.47.1</b>	giunti lineari linear joints	200 pz 200 pcs		1,8

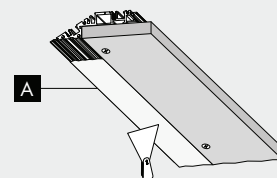

stuccare la superficie **A** del profilo in modo da otturare tutte le scanalature.  
- fill the surface **A** of the profile. ensure all the grooves are filled.

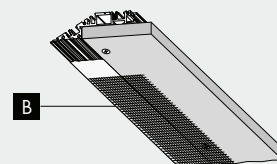

applicare l'apposita garza **B** nella zona di congiunzione tra cartongesso e alluminio.  
- apply the gauze **B** in the area between the plasterboard and aluminium.

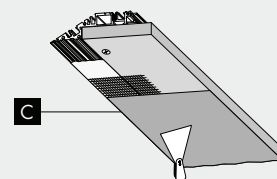

stuccare nuovamente in modo da ottenere una superficie **C** regolare.  
- putty again thus obtaining a smooth surface **C**.

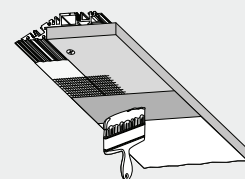

rasare e riverniciare.  
attenzione: alla fine dell'operazione deve risultare una superficie unica e uniforme con il cartongesso.  
- smooth and paint again.  
attention: at the end of the process one surface only on the same level of the plasterboard should be obtained.

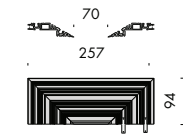
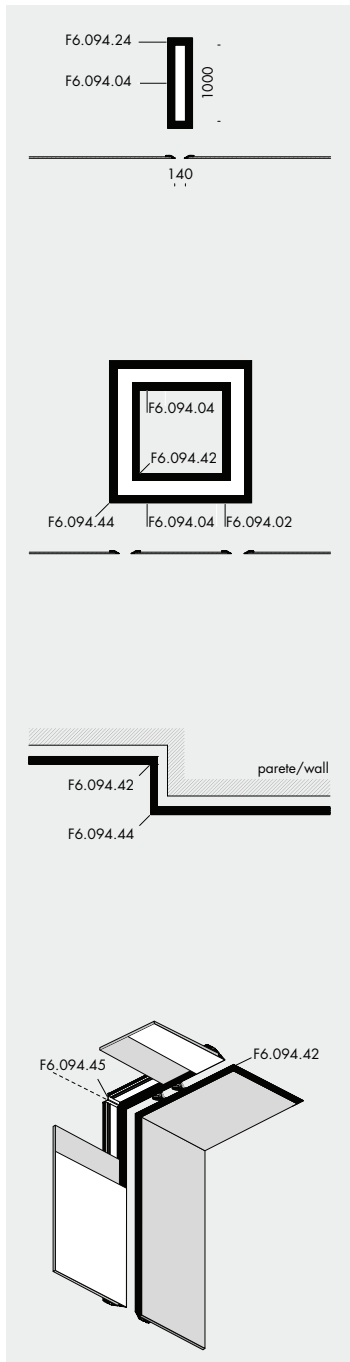

**F6.094.22** testata 70 alluminio naturale  
end plate 70 natural aluminium 2 pz 0,8  
2 pcs

**F6.094.22.N** testata 70 alluminio nero  
end plate 70 black aluminium 2 pz 0,8  
2 pcs

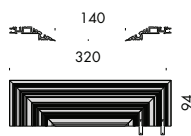

**F6.094.24** testata 140 alluminio naturale  
end plate 140 natural aluminium 2 pz 0,9  
2 pcs

**F6.094.24.N** testata 140 alluminio nero  
end plate 140 black aluminium 2 pz 0,9  
2 pcs



**F6.094.42** raccordo angolare interno alluminio naturale  
natural aluminium internal elbow fitting 0,1

**F6.094.42.N** raccordo angolare interno alluminio nero  
black aluminium internal elbow fitting 0,1



**F6.094.44** raccordo angolare esterno alluminio naturale  
natural aluminium external elbow fitting 0,1

**F6.094.44.N** raccordo angolare esterno alluminio nero  
black aluminium external elbow fitting 0,1



**F6.094.45** raccordo angolare verticale/orizzontale  
external corner vertical/horizontal 0,07



**F6.094.46** set giunti lineari  
set of linear joint 2 pz 0,02  
2 pcs



**F6.094.48** set giunti angolari (interno, esterno) per un angolo  
set of angular joint (interior, exterior) for one corner 2 pz 0,02  
2 pcs

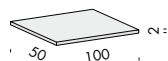

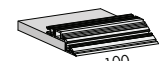

**F6.094.50** spessore compensatore 2mm  
thickness balancer 2mm 20 pz 0,1  
20 pcs



**F6.094.00** campione profilo alluminio naturale  
sample profile natural aluminium 0,3

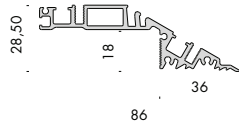



**profilo 094 system h.18** 

<b>F6.094.02.U</b>	profilo alluminio naturale natural aluminium profile	2 pz 2 pcs	500mm	1,3
<b>F6.094.02.N.U</b>	profilo alluminio nero black aluminium profile	2 pz 2 pcs	500mm	1,3
<b>F6.094.04.U</b>	profilo alluminio naturale natural aluminium profile	2 pz 2 pcs	1000mm	2,5
<b>F6.094.04.N.U</b>	profilo alluminio nero black aluminium profile	2 pz 2 pcs	1000mm	2,5
<b>F6.094.06.U</b>	profilo alluminio naturale natural aluminium profile	2 pz 2 pcs	2000mm	5,0
<b>F6.094.06.N.U</b>	profilo alluminio nero black aluminium profile	2 pz 2 pcs	2000mm	5,0
<b>F6.094.08.U</b>	profilo alluminio naturale natural aluminium profile	2 pz 2 pcs	3000mm	7,6
<b>F6.094.08.N.U</b>	profilo alluminio nero black aluminium profile	2 pz 2 pcs	3000mm	7,6
	completi di giunti di congiunzione complete with connection joints			
<b>importante nota per il montaggio:</b> per una buona esecuzione dei lavori nel cartongesso da 12mm utilizzare sempre lo spessore compensatore cod.F6.094.50				
<b>important installation note:</b> for good results when using 12mm plasterboard, item F6.094.50 thickness balancer should always be used.				
<b>* F6.094.09.U</b>	pallet profilo alluminio naturale pallet natural aluminium profile	100 pz 100 pcs	3000mm	412
<b>* F6.094.09.N.U</b>	pallet profilo alluminio nero pallet black aluminium profile	100 pz 100 pcs	3000mm	412
	* giunti esclusi joints excluded			
<b>F6.094.47.1</b>	giunti lineari linear joints	200 pz 200 pcs		1,8

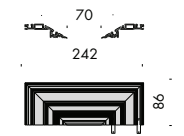

**F6.094.22.U** testata 70 alluminio naturale  
end plate 70 natural aluminium

2 pz 0,8  
2 pcs

**F6.094.22.N.U** testata 70 alluminio nero  
end plate 70 black aluminium

2 pz 0,8  
2 pcs

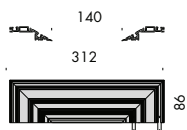

**F6.094.24.U** testata 140 alluminio naturale  
end plate 140 natural aluminium

2 pz 0,9  
2 pcs

**F6.094.24.N.U** testata 140 alluminio nero  
end plate 140 black aluminium

2 pz 0,9  
2 pcs



**F6.094.42.U** raccordo angolare interno alluminio naturale  
natural aluminium internal elbow fitting

0,1

**F6.094.42.N.U** raccordo angolare interno alluminio nero  
black aluminium internal elbow fitting

0,1



**F6.094.44.U** raccordo angolare esterno alluminio naturale  
natural aluminium external elbow fitting

0,1

**F6.094.44.N.U** raccordo angolare esterno alluminio nero  
black aluminium external elbow fitting

0,1



**F6.094.45.U** raccordo angolare verticale/orizzontale  
external corner vertical/horizontal

0,07



**F6.094.46** set giunti lineari  
set of linear joint

2 pz 0,02  
2 pcs

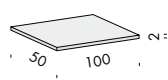

**F6.094.50** spessore compensatore 2mm  
thickness balancer 2mm

20 pz 0,1  
20 pcs

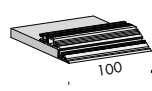

**F6.094.00.U** campione profilo alluminio naturale  
sample profile natural aluminium

0,3

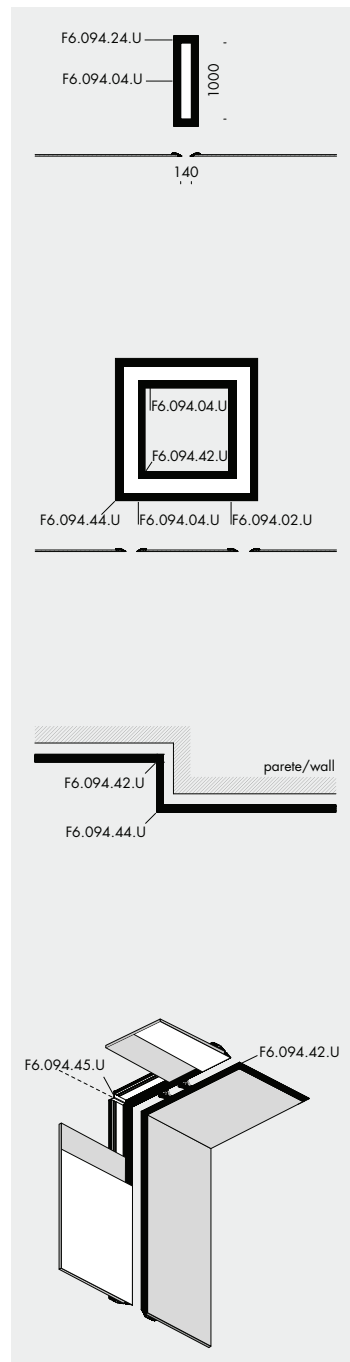

anta girevole/cerniera tipo "A"  
revolving door/type "A" hinge

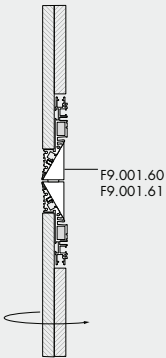

anta girevole pavimento/soffitto  
cerniera tipo "B"  
floor/ceiling revolving door  
type "B" hinge

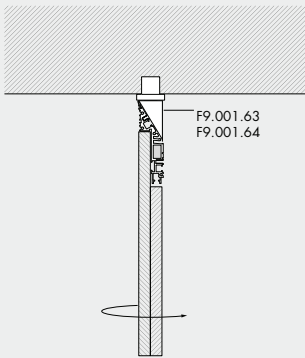

staffa portacarrelli  
bracket for sliding device

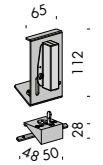
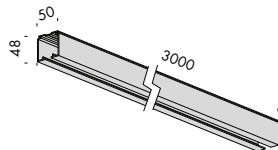
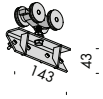
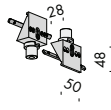
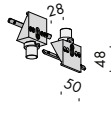
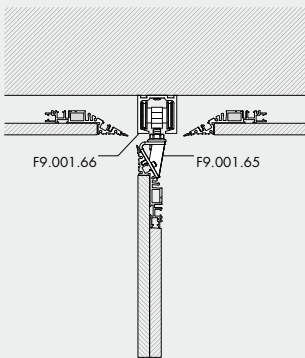

**accessori. accessories**



<b>F9.001.60</b>	cerniera tipo "A" per sportello hinge type "A" for door	2 pz 2 pcs	0,32
<b>F9.001.61</b>	cerniera tipo "A" per sportello con foro per alimentazione hinge type "A" for door with hole for powerfeeding	2 pz 2 pcs	0,30
<b>F9.001.63</b>	cerniera tipo "B" per anta girevole hinge type "B" for revolving door	2 pz 2 pcs	0,38
<b>F9.001.64</b>	cerniera tipo "B" per anta girevole con foro uscita alimentazione Hinge type "B" revolving door with hole for output feeding	2 pz 2 pcs	0,38
	completi di giunti lineari complete with linear joints		
<b>F9.001.62</b>	giunti angolari corner joints	4+4 pz 4+4 pcs	0,06
<b>F9.001.65</b>	staffa portacarrelli bracket for sliding device		0,61
	completa di giunti lineari + 1 carrello complete with linear joints + 1 sliding device		
<b>F9.001.66</b>	binario alluminio anodizzato argento silver anodised aluminium track	3000mm	6,37
<b>F9.001.67</b>	cricchetto premi e apri per sportello Ratchet push-and-open for door		0,46





distanza minima controsoffitto  
minimum ceiling distance

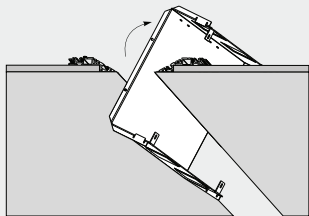
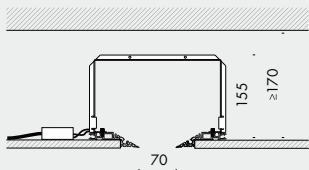

esempio corpo cieco angolo  
F6.094.78/80  
example of blind corner fitting  
F6.094.78/80

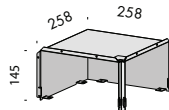
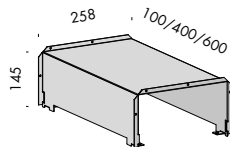
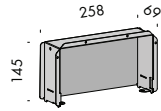
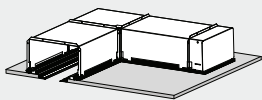
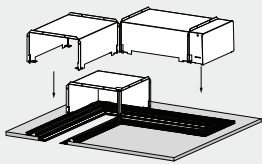

kit 70 carter			CE	i
<b>F6.094.91</b>	testata di chiusura bianco end caps white	2 pz 2 pcs	69mm	0,6
<b>F6.094.92</b>	testata di chiusura nero end caps black	2 pz 2 pcs	69mm	0,6
<b>F6.094.93</b>	corpo cieco bianco blank housing white		100mm	0,3
<b>F6.094.94</b>	corpo cieco nero blank housing black		100mm	0,3
<b>F6.094.95</b>	corpo cieco bianco blank housing white		400mm	1,9
<b>F6.094.96</b>	corpo cieco nero blank housing black		400mm	1,9
<b>F6.094.97</b>	corpo cieco bianco blank housing white		600mm	2,5
<b>F6.094.98</b>	corpo cieco nero blank housing black		600mm	2,5
<b>F6.094.78</b>	corpo cieco angolo bianco blank housing corner white			1,4
<b>F6.094.80</b>	corpo cieco angolo nero blank housing corner black			1,4

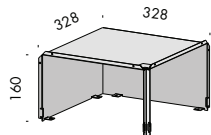
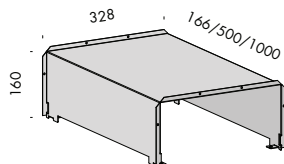
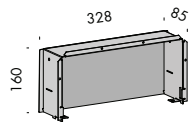

kit 140 carter			CE	i
----------------	--	--	----	---

<b>F6.094.73</b>	testata di chiusura bianco end caps white	2 pz 2 pcs	85mm	1,7
------------------	--	---------------	------	-----

<b>F6.094.74</b>	testata di chiusura nero end caps black	2 pz 2 pcs	85mm	1,7
------------------	--	---------------	------	-----

<b>F6.094.71</b>	corpo cieco bianco blank housing white		166mm	0,9
------------------	---	--	-------	-----

<b>F6.094.72</b>	corpo cieco nero blank housing black		166mm	0,9
------------------	---	--	-------	-----

<b>F6.094.75</b>	corpo cieco bianco blank housing white		500mm	2,5
------------------	---	--	-------	-----

<b>F6.094.76</b>	corpo cieco nero blank housing black		500mm	2,5
------------------	---	--	-------	-----

<b>F6.094.70</b>	corpo cieco nero blank housing black		1000mm	5,0
------------------	---	--	--------	-----

<b>F6.094.70.B</b>	corpo cieco bianco blank housing white		1000mm	5,0
--------------------	---	--	--------	-----

<b>F6.094.77</b>	corpo cieco angolo bianco blank housing corner white			2,1
------------------	---	--	--	-----

<b>F6.094.79</b>	corpo cieco angolo nero blank housing corner black			2,1
------------------	---	--	--	-----

distanza minima controsoffitto  
minimum ceiling distance

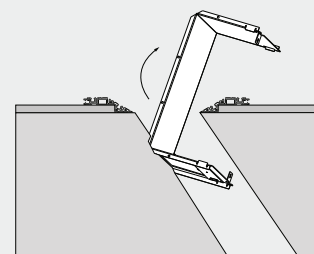
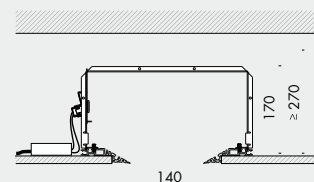

esempio corpo cieco angolo  
F6.094.77/79  
example of blind corner fitting  
F6.094.77/79

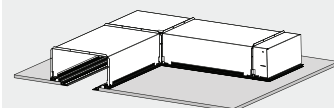
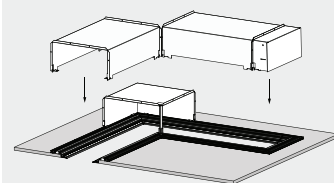

esempio di installazione  
installation example

foro/opening	a
100x100	172
Ø100	212
140x140	212
Ø140	252

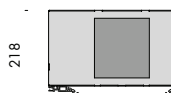
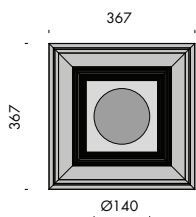
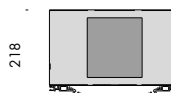
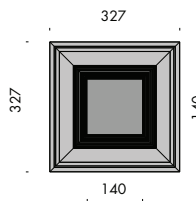
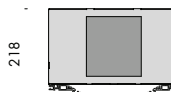
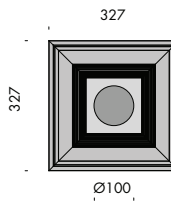
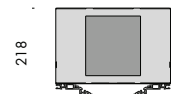
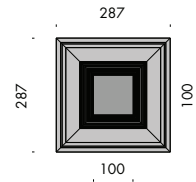
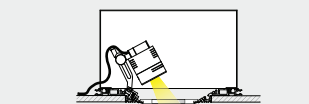
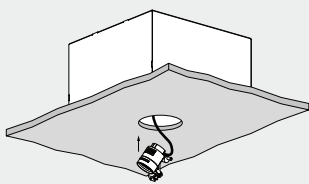
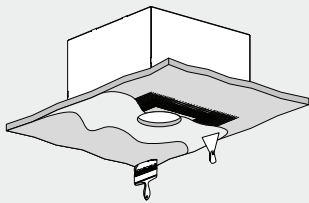
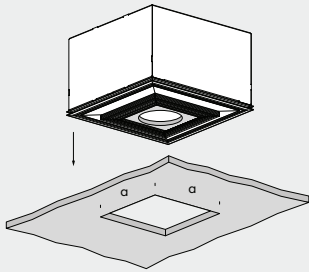

**scomparsa totale 100**



**F6.098.01** nero black 100x100mm

**F6.098.02** bianco white 100x100mm

**F6.098.03** nero black Ø100mm

**F6.098.04** bianco white Ø100mm

**scomparsa totale 140**



**F6.098.11** nero black 140x140mm

**F6.098.12** bianco white 140x140mm

**F6.098.13** nero black Ø140mm

**F6.098.14** bianco white Ø140mm

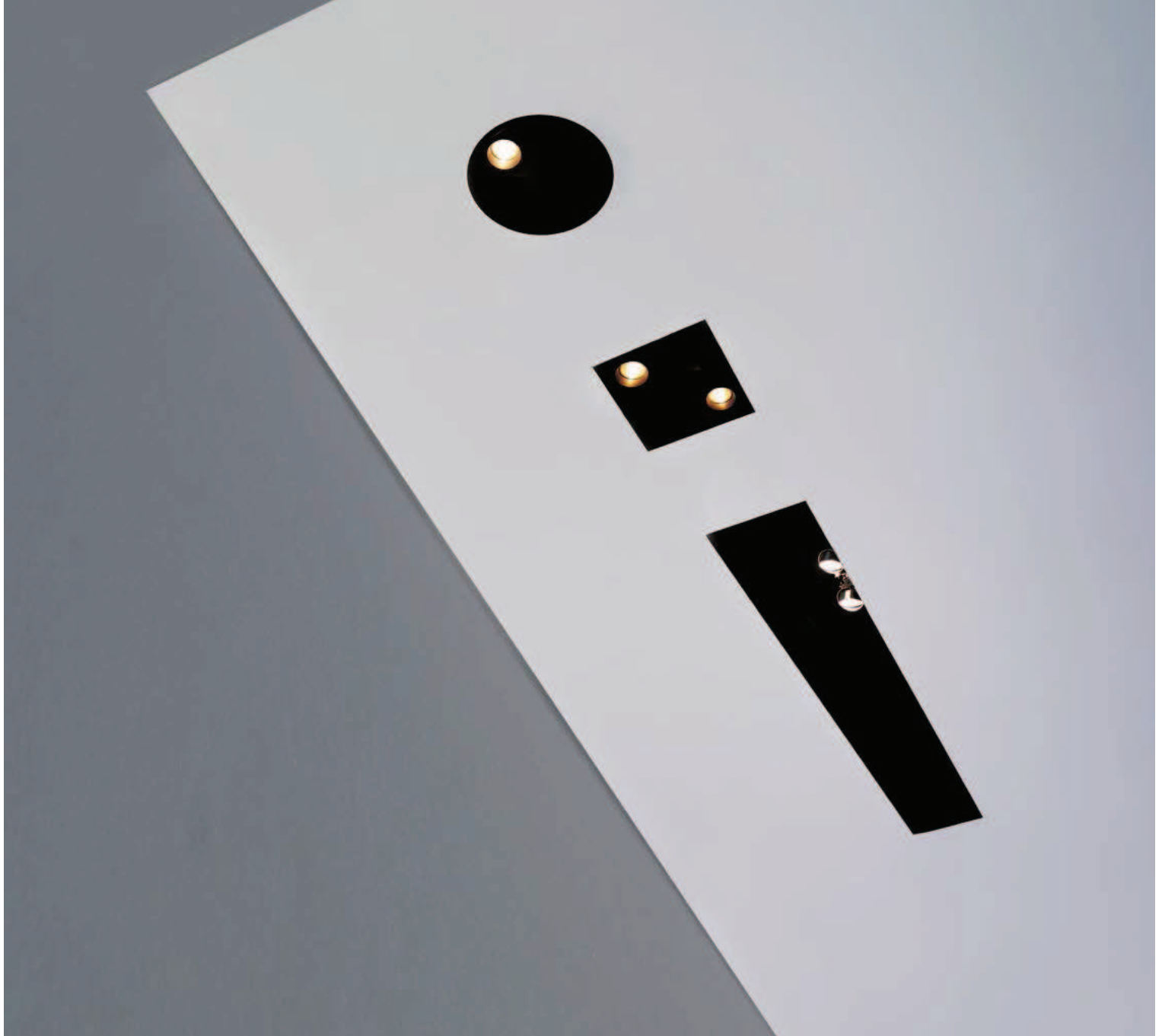

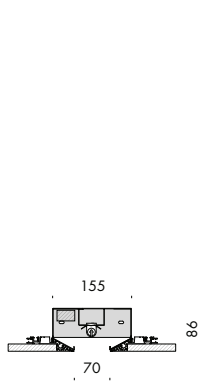

094 kit 70mm fluo		240	50-60Hz	A	ECG	⊕ IP20	∇	CE	i
<b>F6.095.31</b>	fluo fluo	G5	14/24W			HE/HO	600mm		2,5
<b>F6.095.31.SA</b>	fluo+emergenza fluo+emergency	G5	14/24W			HE/HO	600mm		2,9
<b>F6.095.31.D1</b>	fluo dimm 1-10V fluo dimm 1-10V	G5	14/24W			HE/HO	600mm		2,6
<b>F6.095.31.D2</b>	fluo dimm dali fluo dimm dali	G5	14/24W			HE/HO	600mm		2,6
<b>F6.095.32</b>	fluo fluo	G5	21/39W			HE/HO	900mm		3,8
<b>F6.095.32.SA</b>	fluo+emergenza fluo+emergency	G5	21/39W			HE/HO	900mm		4,2
<b>F6.095.32.D1</b>	fluo dimm 1-10V fluo dimm 1-10V	G5	21/39W			HE/HO	900mm		3,9
<b>F6.095.32.D2</b>	fluo dimm dali fluo dimm dali	G5	21/39W			HE/HO	900mm		3,9
<b>F6.095.33</b>	fluo fluo	G5	28/54W			HE/HO	1200mm		5,0
<b>F6.095.33.SA</b>	fluo+emergenza fluo+emergency	G5	28/54W			HE/HO	1200mm		5,4
<b>F6.095.33.D1</b>	fluo dimm 1-10V fluo dimm 1-10V	G5	28/54W			HE/HO	1200mm		5,1
<b>F6.095.33.D2</b>	fluo dimm dali fluo dimm dali	G5	28/54W			HE/HO	1200mm		5,1
<b>F6.095.34</b>	fluo fluo	G5	35/49/80W			HE/HO	1500mm		6,2
<b>F6.095.34.SA</b>	fluo+emergenza fluo+emergency	G5	35/49/80W			HE/HO	1500mm		6,6
<b>F6.095.34.D1</b>	fluo dimm 1-10V fluo dimm 1-10V	G5	35/49/80W			HE/HO	1500mm		6,3
<b>F6.095.34.D2</b>	fluo dimm dali fluo dimm dali	G5	35/49/80W			HE/HO	1500mm		6,3

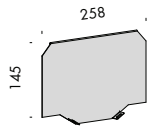
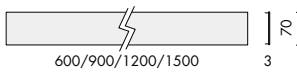

componenti kit 70mm fluo. kit 70mm fluo components.		€	i
---	--	---	---

<b>F9.095.50</b>	ottica darklight darklight louvers	600mm	0,15
<b>F9.095.51</b>	ottica darklight darklight louvers	900mm	0,20
<b>F9.095.52</b>	ottica darklight darklight louvers	1200mm	0,27
<b>F9.095.53</b>	ottica darklight darklight louvers	1500mm	0,34
<b>F9.095.40</b>	policarbonato opalino opal polycarbonate	600mm	0,15
<b>F9.095.41</b>	policarbonato opalino opal polycarbonate	900mm	0,20
<b>F9.095.42</b>	policarbonato opalino opal polycarbonate	1200mm	0,27
<b>F9.095.43</b>	policarbonato opalino opal polycarbonate	1500mm	0,34
<b>F9.095.44</b>	policarbonato opalino opal polycarbonate	3000mm	0,42

accessori. accessories.		€	i
-------------------------	--	---	---

<b>F9.094.81</b>	piastra testata kit 70 cieco/fluvo bianca white head plate blind kit 70/fluvo	0,6	
<b>F9.094.82</b>	piastra testata kit 70 cieco/fluvo nera black head plate blind kit 70/fluvo	0,6	

esempio di montaggio con policarbonato opalino  
installation example with opal polycarbonate

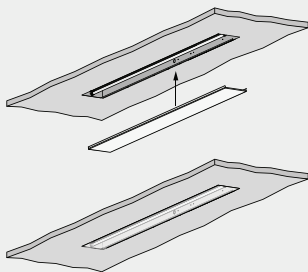

esempio di montaggio con ottica darklight  
installation example with darklight louvers

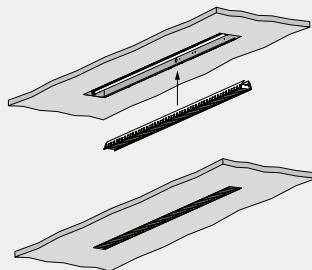

esempio di installazione kit fluvo con piastra cieca su taglio da 70mm  
example of fluorescent kit installation with blank plate over a 70mm opening

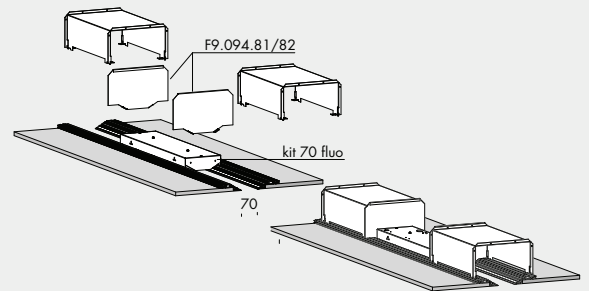

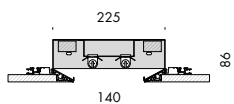
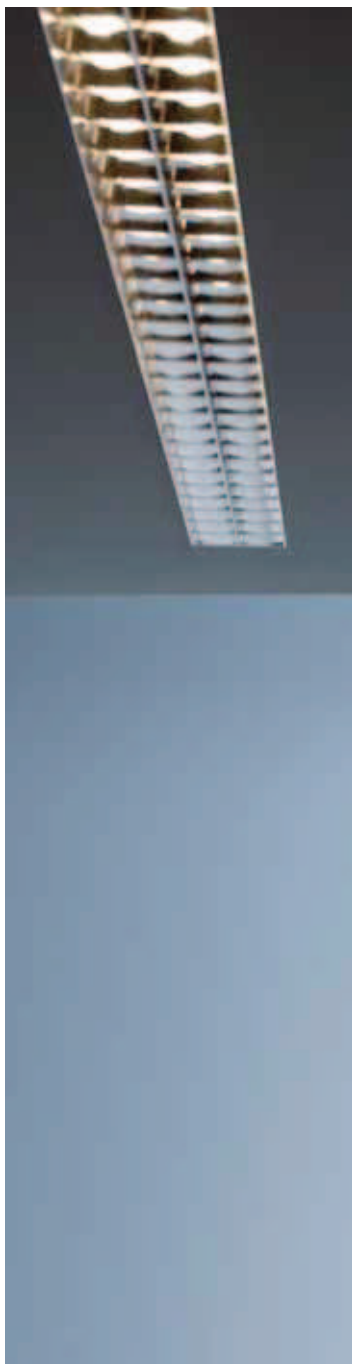

<b>094 kit 140mm fluo</b>		<b>240 50-60Hz</b>	<b>A ECG</b>	<b>⊕ IP20</b>	<b>CE</b>	<b>i</b>
<b>F6.095.61</b>	fluo fluo	G5	2x14/24W	HE/HO 600mm	2,60	
<b>F6.095.61.SA</b>	fluo+emergenza fluo+emergency	G5	2x14/24W	HE/HO 600mm	3,00	
<b>F6.095.61.D1</b>	fluo dimm 1-10V fluo dimm 1-10V	G5	2x14/24W	HE/HO 600mm	2,70	
<b>F6.095.61.D2</b>	fluo dimm dali fluo dimm dali	G5	2x14/24W	HE/HO 600mm	2,70	
<b>F6.095.62</b>	fluo fluo	G5	2x21/39W	HE/HO 900mm	4,00	
<b>F6.095.62.SA</b>	fluo+emergenza fluo+emergency	G5	2x21/39W	HE/HO 900mm	4,50	
<b>F6.095.62.D1</b>	fluo dimm 1-10V fluo dimm 1-10V	G5	2x21/39W	HE/HO 900mm	4,20	
<b>F6.095.62.D2</b>	fluo dimm dali fluo dimm dali	G5	2x21/39W	HE/HO 900mm	4,20	
<b>F6.095.63</b>	fluo fluo	G5	2x28/54W	HE/HO 1200mm	5,20	
<b>F6.095.63.SA</b>	fluo+emergenza fluo+emergency	G5	2x28/54W	HE/HO 1200mm	5,70	
<b>F6.095.63.D1</b>	fluo dimm 1-10V fluo dimm 1-10V	G5	2x28/54W	HE/HO 1200mm	5,40	
<b>F6.095.63.D2</b>	fluo dimm dali fluo dimm dali	G5	2x28/54W	HE/HO 1200mm	5,40	
<b>F6.095.64</b>	fluo fluo	G5	2x35/49	HE/HO 1500mm	6,50	
<b>F6.095.64.SA</b>	fluo+emergenza fluo+emergency	G5	2x35/49	HE/HO 1500mm	7,00	
<b>F6.095.64.D1</b>	fluo dimm 1-10V fluo dimm 1-10V	G5	2x35/49/80W	HE/HO 1500mm	6,70	
<b>F6.095.64.D2</b>	fluo dimm dali fluo dimm dali	G5	2x35/49	HE/HO 1500mm	6,70	

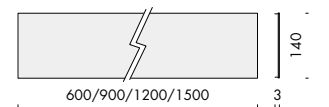
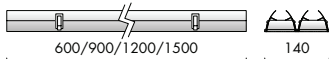
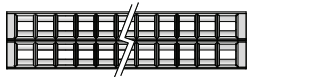

**componenti kit 140mm fluo. kit 140mm fluo components.** € ⓘ

<b>F9.095.80</b>	ottica darklight darklight louvre	600mm	0,25
<b>F9.095.81</b>	ottica darklight darklight louvre	900mm	0,38
<b>F9.095.82</b>	ottica darklight darklight louvre	1200mm	0,50
<b>F9.095.83</b>	ottica darklight darklight louvre	1500mm	0,65
<b>F9.095.70</b>	policarbonato opalino opal polycarbonate	600mm	0,25
<b>F9.095.71</b>	policarbonato opalino opal polycarbonate	900mm	0,38
<b>F9.095.72</b>	policarbonato opalino opal polycarbonate	1200mm	0,50
<b>F9.095.73</b>	policarbonato opalino opal polycarbonate	1500mm	0,65
<b>F9.095.74</b>	policarbonato opalino opal polycarbonate	3000mm	0,80

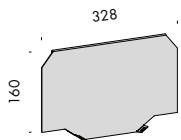

**accessori. accessories.** € ⓘ

<b>F9.094.83</b>	piastra testata kit 140 cieco/fluo bianca white head plate blind kit 140/fluor	0,6
<b>F9.094.84</b>	piastra testata kit 140 cieco/fluo nera black head plate blind kit 140/fluor	0,6

esempio di montaggio con policarbonato opalino  
installation example with opal polycarbonate

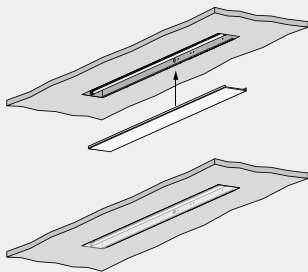

esempio di montaggio con ottica darklight  
installation example with darklight louvre

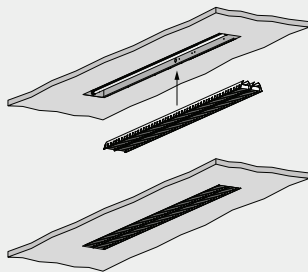

esempio di installazione kit fluo con piastra cieca su taglio da 140mm  
example of fluorescent kit installation with blank plate over a 140mm opening

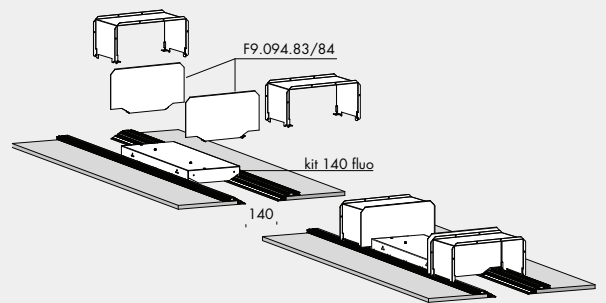





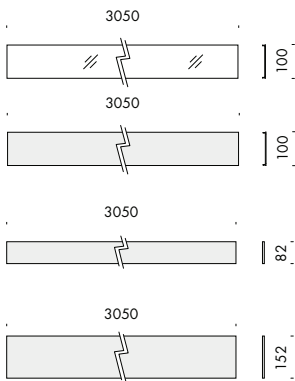

**accessori. accessories.** CE ⓘ

- F9.202.82** coperchio metacrilato trasparente  
transparent methacrylate cover
- F9.202.84** coperchio policarbonato sabbato  
frosted polycarbonate cover
- \*F9.202.92** coperchio policarbonato sabbato, solo per taglio 70mm  
frosted polycarbonate cover for slot only 70mm
- \*F9.202.94** coperchio policarbonato sabbato, solo per taglio 140mm  
frosted polycarbonate cover for slot only 140mm

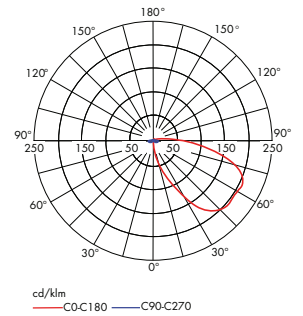

\* non utilizzare nel montaggio a parete  
don't use in case of wall mounting

linea di luce continua  
esempio di montaggio  
installation example

bloccaggio linea di luce su profilo 094  
linea di luce fastening to 094 profile

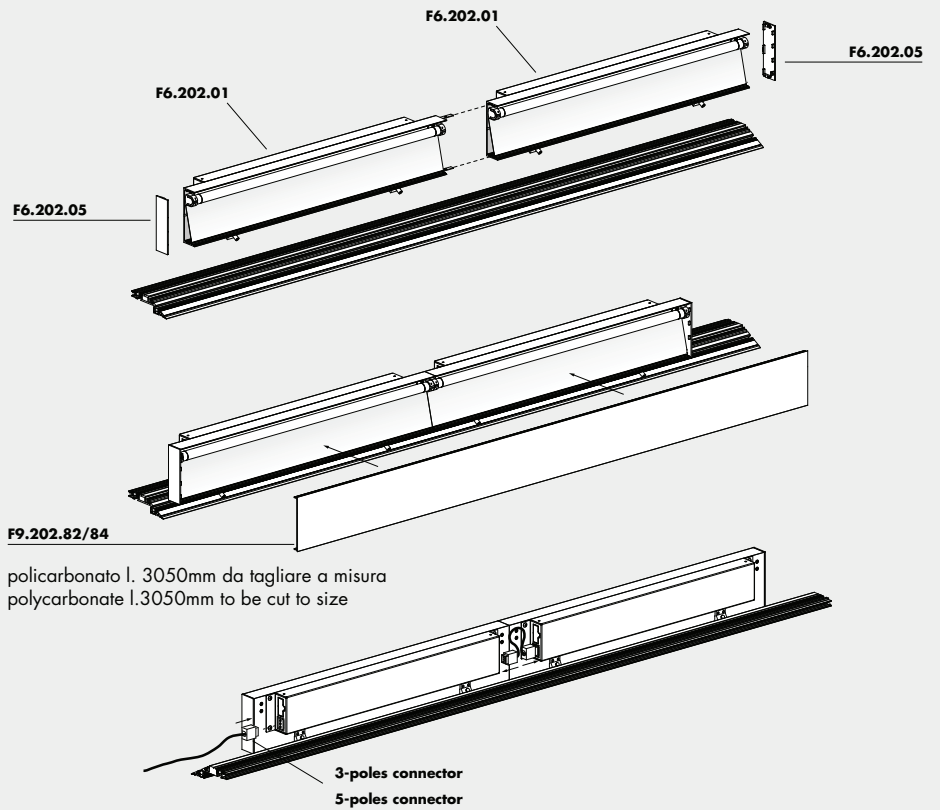
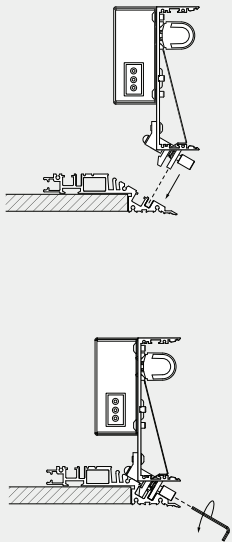

policarbonato l. 3050mm da tagliare a misura  
polycarbonate l.3050mm to be cut to size