

### KPL User Options Mode

The User Options Mode allows the user to adjust the audio properties of a particular zone. The audio features that can be adjusted are: Bass, Treble, Balance, Turn On Volume and Loudness.

To enter the User Options Mode, press and hold the Source button when the zone is on. Press and hold the Source button again (or a 9-second timeout) returns to regular operation.

The first option name (Bass) appears on the display to indicate it is ready for adjustment. Subsequent presses of the Source button toggle through Treble, Balance, Turn On Volume and Loudness.

Once an option is selected, the volume up/down buttons are used to adjust settings. The volume indicator bars indicate the option setting, along with setting numbers displayed on the LCD.

### Options and Settings

1. Bass: -10 < Bass:Flat > +10
2. Treb (Treble): -10 < Treble:Flat > +10
3. Bal (Balance): Left 10 < Center > Right 10
4. OnVol (Turn on Volume) (default room volume level): 0 to 100 (in steps of 2)
5. Loud (Loudness) (more bass, fuller sound): On or Off (When Loudness is turned on, the blue LED lights solid)

### KPL Diagnostics Menu

The Diagnostics Menu allows the installer to run a diagnostic check on the KPL and to verify the firmware version.

To access the Diagnostics Menu, press and hold the Setup button on the right side of the keypad until "Diags" appears

on the display. The menus are outlined in the diagram below.

When finished, press and release the Setup button again.

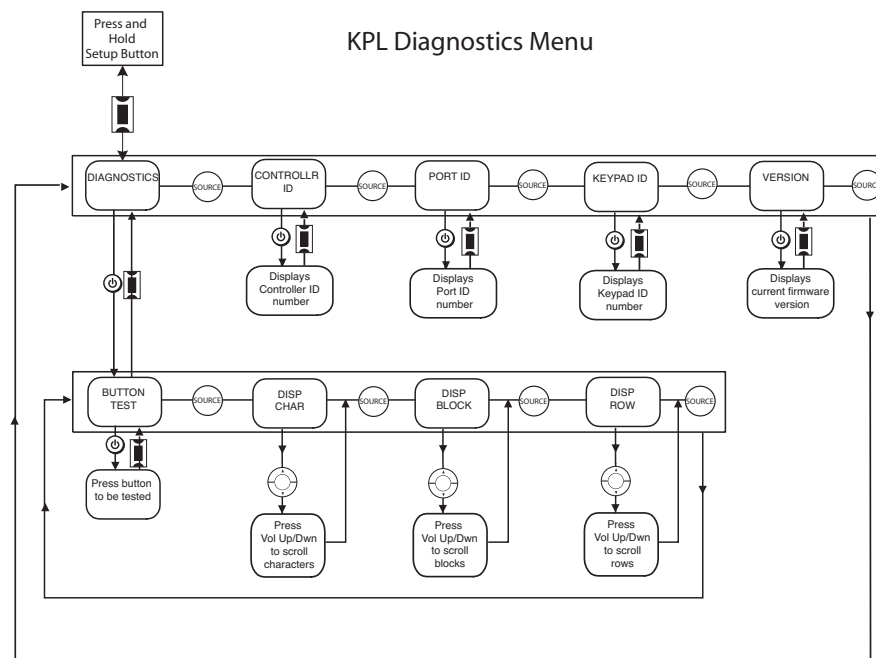

### Warranty Repair

The Russound KPL is fully guaranteed against all defects in materials and workmanship for two (2) years from the date of purchase. During this period, Russound will replace any defective parts and correct any defect in workmanship without charge for either parts or labor.

For this warranty to apply, the unit must be installed and used according to its written instructions. If service is necessary, it must be performed by Russound. The unit must be returned to Russound at the owner's expense and with prior written permission. Accidental damage and shipping damage are not considered defects, nor is damage resulting from abuse or from servicing by an agency or person not specifically authorized in writing by Russound.

This Warranty does not cover: Damage caused by abuse, accident, misuse, negligence, or improper installation or operation; Power surges and lightning strikes; Normal wear and maintenance; Products that have been altered or modified; Any product whose identifying number, decal, serial number, etc. has been altered, defaced or removed.

Russound sells products only through authorized Dealers and Distributors to ensure that customers obtain proper support and service. Any Russound product purchased from an unauthorized dealer or other source, including retailers, mail order sellers and online sellers will not be honored or serviced under existing Russound warranty policy. Any sale of products by an unauthorized source or other manner not authorized by Russound shall void the warranty on the applicable product.

Damage to or destruction of components due to application of excessive power voids the warranty on those parts. In these cases, repairs will be made on the basis of the retail value of the parts and labor. To return for repairs, the unit must be shipped to Russound at the owner's expense, along with a note explaining the nature of service required. Be sure to pack the unit in a corrugated container with at least three (3) inches of resilient material to protect the unit from damage in transit. Before returning a unit for repair, call Russound at (603) 659-5170 for a Return Authorization number. Write this number on the shipping label and ship to: Russound, ATTN: Service, 5 Forbes Road, Newmarket, NH 03857

Due to continual efforts to improve product quality as new technology and techniques become available, Russound/FMP, Inc. reserves the right to revise system specifications without notice.

*All trademarks are property of their respective owners.*



5 Forbes Road, Newmarket, NH 03857  
tel 603.659.5170 • fax 603.659.5388  
www.russound.com

# KPL Keypad

The KPL keypad is an in-wall, Decora® style single-gang keypad designed for individual zone control of CAA66/CAS44 distributed audio systems (wall plate not included). It has amber backlit, soft-touch volume, power and source select buttons. The KPL keypad supports the KPSC keypad to add source control and numeric control capability.

### KPL Keypad Front Panel

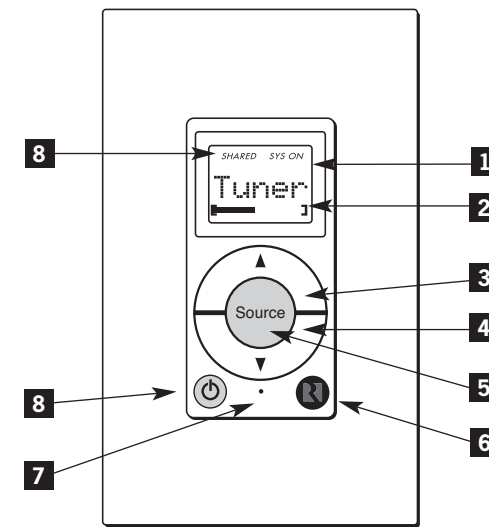

- 1 LCD PANEL - 5-character amber backlit display shows source name, volume and room status.
- 2 VOLUME LEVEL - 21-segment volume level bars increase from left to right to indicate volume level.
- 3 VOLUME UP - Raises the volume for the room/adjusts menu items.
- 4 VOLUME DOWN - Lowers the volume for the room/adjusts menu items.
- 5 SOURCE SELECT - Press and release scrolls through the available sources. Press and hold brings up the USER MENU for Loudness, Bass, Treble, etc.
- 6 IR RECEIVER - Receives IR signals and passes them to the controller and source equipment. Also used when the keypad is operated using the CA System remote controls.
- 7 IR CONFIRMATION/LOUDNESS LED - Blue LED blinks to confirm IR signal reception, and remains lighted when Loudness feature is enabled.
- 8 POWER - Turns room ON or OFF when pressed once, when OFF, press and hold 4 seconds to turn OFF all zones; button remains lit when OFF if any other zone in the system is ON.
- 9 SYSTEM INFO - SYS ON indicates other active zones and SHARED indicates the selected source is in use in another zone.

## KPL Side Panel

The KPL setup button and KPSC 12-pin header are located on the right side of the keypad (when facing front). These are covered when a trim plate is installed.

- 1** OS UPDATE/RUN JUMPER -The pins are jumpered only when performing an OS update on the keypad, and removed during normal operation.
- 2** SETUP BUTTON - Activates information and update menus for the keypad.
- 3** KPSC PORT - 12-pin header for connecting to KPSC keypad.

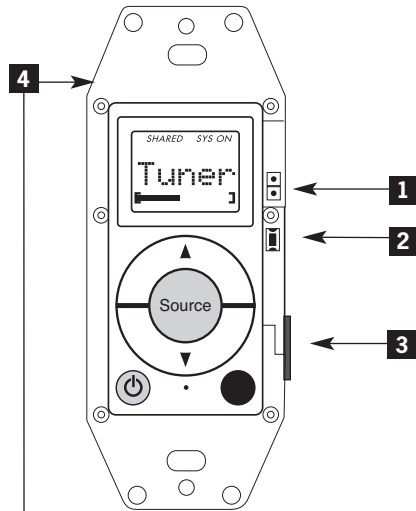

KPL Front View

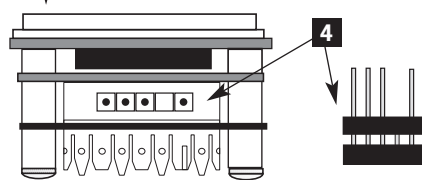

KPL Top View

- 4** OS UPDATE PORT - Used to update the KPL keypad operating system firmware. If an update is released, it will be available online through the Document Center on [www.russound.com](http://www.russound.com). Look in the "Firmware and Downloads" section under Multi-Zone product type. The Advanced Programming Cable is available from Russound, Part #2500-521065.

## KPL Back Panel

The KPL keypad uses a 110-punchdown terminal on the back panel to provide a simple installation and strong connection for CAT-5 cable's eight conductors. Punchdown terminals require the use of a punchdown tool. Attach the CAT-5 cable to the 110-punchdown terminal on the KPL keypad as shown, matching the conductor colors to the connection color guide. The keypad will not operate properly if the terminations deviate from the required connection order.

Take care when using an impact 110 punchdown tool, as this may overspread the contact points. Be sure to use the lowest setting. Use of the impact tool may propel stray bits of wire and jacket into the keypad's chassis and possibly cause a short in the circuitry. Gently shake or blow air through the keypad chassis to remove stray wire before the keypad is installed in the junction box.

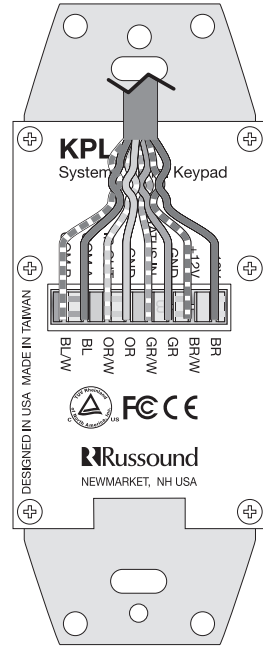

CAT-5 to KPL Connection

## Keypad Installation

1. Check whether or not you can route the wire to the location you have chosen.
2. To install a single-gang keypad, you will need to use a UL/CSA approved plastic single-gang (18 ci) electrical box.
3. Route CAT-5 wire to the junction box from the CA system controller.
4. Use a 110 punchdown tool to connect each wire to its corresponding color labeled on the punchdown terminal.
5. Mount the keypad in the electrical box and attach the trim plate.

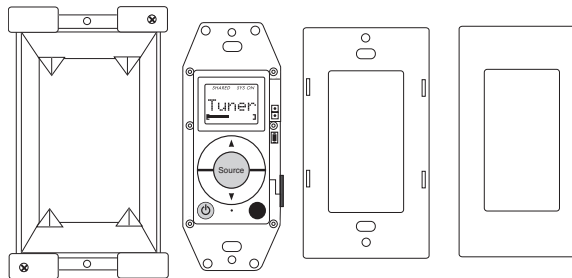

Electrical Box KPL Keypad Back Plate Trim Plate

## KPL Keypad to CA Controller Connection

Each keypad connects to a Keypad Port on the back of the controller (CAA66 controller shown below). Connections are made using CAT-5 cable with an RJ45 connector (wiring scheme shown below).

An SA-ZX3 Keypad Splitter can be used to add additional keypads to each zone.

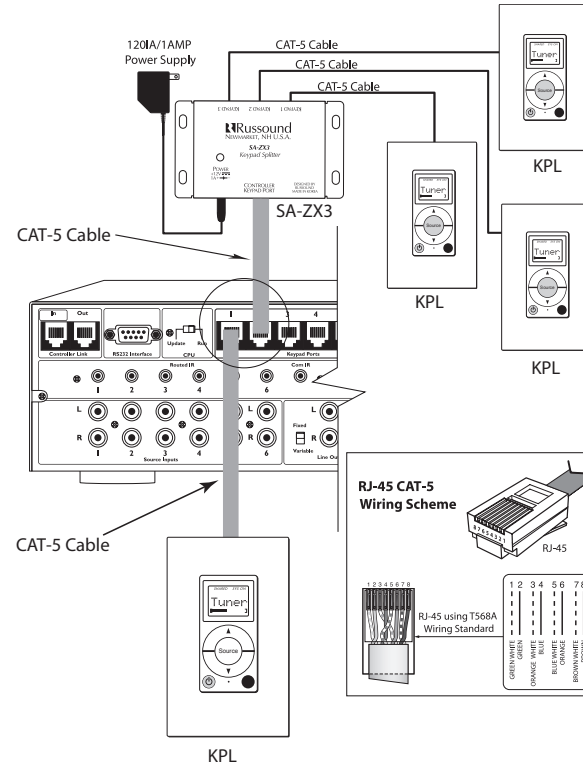

## Technical Specifications

**Dimensions:** 1.875"W x 2.7"D x 1.47"H  
(4.7 x 6.9 x 3.7 cm)  
Fits 1 Gang UL/CSA Approved 18 ci Junction Box

**Weight:** 4.5 oz. (127.6 g)

**Power Requirements:** 12 VDC 180mA

**CAT-5 Connection:** 110 punchdown

## Safety Instructions

1. Read Instructions - All the safety and operating instructions should be read before the appliance is operated.
2. Retain Instructions - The safety and operating instructions should be retained for future reference.
3. Heed Warnings - All warnings on the appliance in the operating instructions should be adhered to.
4. Follow Instructions - All operating and user instructions should be followed.
5. Water and Moisture - The appliance should not be used near water; for example, near a bathtub, washbowl, kitchen sink, laundry tub, in a wet basement, or near a swimming pool.
6. Wall Mounting - The appliance should be mounted to a wall only as recommended by the manufacturer.
7. Ventilation - The appliance should be situated so that its location or position does not interfere with its proper ventilation. For example, the appliance should not be situated on a bed, sofa, rug, or similar surface that may block the ventilation openings, or placed in a built-in installation, such as a bookcase or cabinet that may impede the flow of air through the ventilation openings.
8. Heat - The appliance should be situated away from heat sources such as radiators, heat registers, stoves, or other appliances (including amplifiers) that produce heat.
9. Power Sources - The appliance should be connected to a power supply only of the type described in the operating instructions or as marked on the appliance.
10. Grounding or Polarization - Precaution should be taken so that the grounding or polarization means of an appliance is not defeated.
11. Object and Liquid Entry - Care should be taken so that objects do not fall and liquids are not spilled into the enclosure through the openings.
12. Damage Requiring Service - The appliance should be serviced by qualified service personnel when:
  - A. Objects have fallen, liquid has been spilled into the appliance; or
  - B. The appliance has been exposed to rain; or
  - C. The appliance does not appear to operate normally; or
  - D. The appliance has been dropped or the enclosure is damaged.
13. Servicing - The user should not attempt to service the appliance beyond that described in the operating instructions. All other servicing should be referred to qualified service personnel.

## Precautions:

1. Power – WARNING: BEFORE TURNING ON THE POWER FOR THE FIRST TIME, READ THE FOLLOWING SECTION CAREFULLY.
2. Do Not Touch The Unit With Wet Hands – Do not handle the unit when your hands are wet or damp. If water or any other liquid enters the unit's cabinet, take it to a qualified service person for inspection.
3. Care – From time to time you should wipe off the front panel of the cabinet with a soft cloth. Do not use rough material, thinners, alcohol or other chemical solvents or cloths since this may damage the finish or remove the panel lettering.

